

EIGENSCHAFTEN

- Mit zwei fest montierten Rädern ausgestattet, leicht zu bewegen.
- Gitter problemlos austauschbar.
- Kein elektrischer Anschluss erforderlich.
- Magnetischer Mehlbehälter.
- Geringer Platzbedarf.
- Platzsparende Unterbringung für 4 Gitter.
- Mit Teigteilwanne und 2 Gitter ausgestattet.
- Manuelles Teilen und Formen des Teiges.

CARACTERÍSTICAS

- Montado sobre dos ruedas fijas, fácil de mover.
- Parrillas de corte fácilmente intercambiables.
- No es necesaria conexión eléctrica.
- Caja magnética para la harina.
- Ocupa poco espacio.
- Almacenaje de 4 parrillas.
- Equipado con un contenedor divisor y 2 rejillas de corte.
- Cortado y moldeado manual de la pasta.

CARATTERISTICHE

- Facile da spostare grazie alle due rotelle fisse.
- Griglie facilmente intercambiabili.
- Non richiede collegamenti elettrici.
- Vaschetta magnetica per farina.
- Ingombro ridotto.
- Spazio per 4 griglie.
- Dotata di vasca di divisione e 2 griglie.
- Divisione e formatura manuali.



2 YEARS
WARRANTY



Gitter problemlos austauschbar.

Parrilla de corte fácilmente intercambiables.

Griglie facilmente intercambiabili.

Magnetischer Mehlbehälter.
Contenedor magnético para la harina.
Contenitore magnetico per farina.

Herausziehbare Halterung für die Teigteilwanne.
Apoyo extraíble para el contenedor de división.
Supporto estraibile per il cestello di divisione.

Pressplatte ebenfalls erhältlich.
También está disponible una placa de prensado.
Disponibile anche la piastra di pressione.

Unterbringung für 4 Gitter.
Almacenaje para 4 parrillas.
Spazio per 4 griglie.

Option: Blechwagen

Opción: carro para contenedores

Opzione: carrello per teglie

Teigwanne Cubetas Recipienti	14
Deckel Tapas Coperchi	14
Kapazität Capacidad Capacità	9,8 L (5 - 6 kg)



SEITENSICHT | PERFIL | VISTA LATERALE

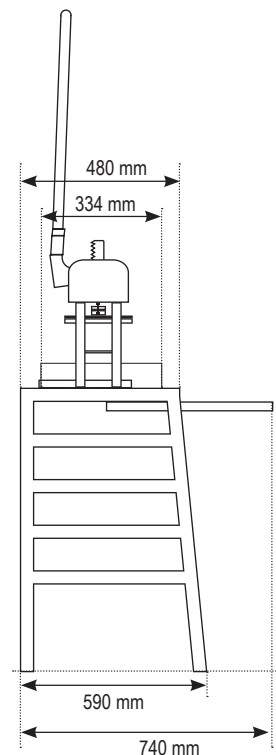

VORDERANSICHT | ALZADO | VISTA FRONTALE

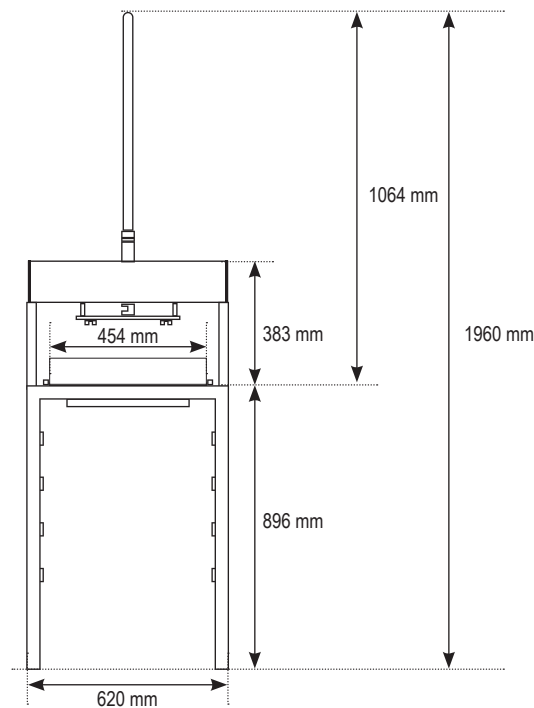

KUNSTSTOFFGITTER | PARRILLA EN PLÁSTICO | GRIGLIA IN PLASTICA

Einzelne Teilung | división simple | Divisione semplice



MSG101001P

10 (10 x 1)

180 - 500 gr

30 x 334 mm



MSG080801P

8 (8 x 1)

225 - 625 gr

41 x 334 mm

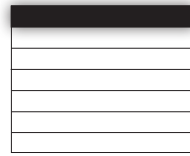

MSG070107P

7 (1 x 7)

255 - 710 gr

454 x 47 mm

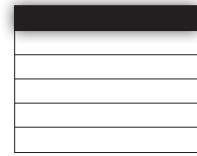

MSG060106P

6 (1 x 6)

300 - 830 gr

454 x 54 mm

Doppelte Teilung | Doble división | Divisione doppia

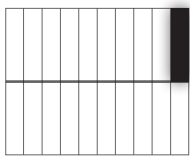

MSG201002P

20 (10 x 2)

90 - 250 gr

30 x 160 mm



MSG160802P

16 (8 x 2)

110 - 310 gr

41 x 160 mm



MSG140207P

14 (2 x 7)

125 - 355 gr

224 x 45 mm

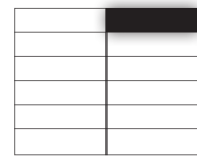

MSG120206P

12 (2 x 6)

150 - 415 gr

224 x 54 mm

Gitter mit profilierten Messern:
 Profiliertes Messer aus POM-Kunststoff, für Nahrungsmittel geeignet, für ein ausgezeichnetes verschließen des Teiges bei der Teigteilung.

Parrillas con cuchillas perfiladas:
 Cuchillas perfiladas de polioximetileno, aptas para uso comestibles, para una soldadura perfecta de la masa mientras la división.

Griglie con lame sagomate:
 Lame sagomate di polioximetilene, idonee per l'uso di alimenti, per una saldatura perfetta della pasta nella divisione.

GITTER AUS EDELSTAHL | PARRILLA EN ACERO INOX | GRIGLIA IN ACCIAIO INOSSIDABILE

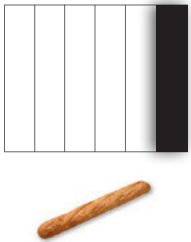

MSG060601
6 (6 x 1)
 300 - 1000 gr
 73 x 334 mm

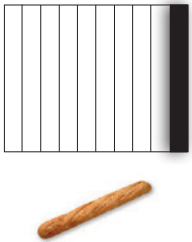

MSG080801
8 (8 x 1)
 225 - 750 gr
 54 x 334mm

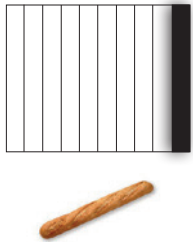

MSG101001
10 (10 x 1)
 180 - 600 gr
 42 x 334 mm



MSG100502
10 (5 x 2)
 180 - 600 gr
 88 x 160 mm

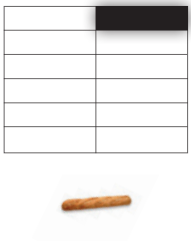

MSG120206
12 (2 x 6)
 150 - 500 gr
 224 x 53 mm



MSG120403
12 (4 x 3)
 150 - 500 gr
 115 x 108 mm



MSG140207
14 (2 x 7)
 125 - 425 gr
 224 x 47 mm



MSG210703
21 (7 x 3)
 85 - 285 gr
 62 x 108 mm

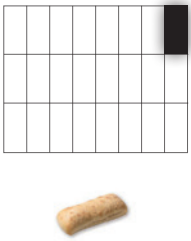

MSG240803
24 (8 x 3)
 75 - 250 gr
 57 x 108 mm

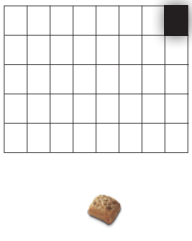

MSG400805
40 (8 x 5)
 45 - 125 gr
 54 x 64 mm

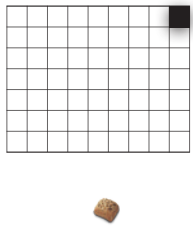

MSG630907
63 (9 x 7)
 25 - 63 gr
 47 x 45 mm

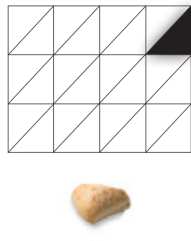

MSG240403/2
24 (4 x 3) x 2
 75 - 165 gr
 115 x 108 x 150 mm

Gewicht und Abmessungen können je nach Teigart variieren. ■ El peso y las dimensiones pueden variar según el tipo de masa. ■ Peso e dimensioni possono variare a seconda del tipo di impasto.